

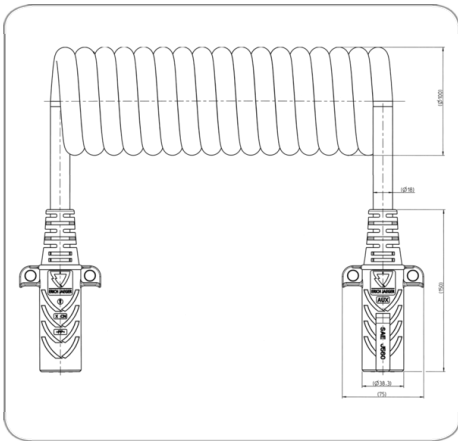

DATAsheet

7P/12V coil (SAE J560 - Auxiliary)



Art.Nr.
Part. No.

611223

Product group	Coil
Industry	Commercial vehicles
No. of poles	7
Voltage [in V]	12
Standard	SAE J560 - Auxiliary
Packaging	without packaging
No. of connected plugs	2
No. of connected sockets	0
Housing material	reinforced composite
Housing color	black
Contact insert color	black
Cable outlet	molded, bending protection
Mounting of cable and socket/plug	molded
Working length [in feet]	12.0
Working length [in m]	3.5
Max. working length [in m]	4.0
Max. extension length [in feet]	15.0
Max. extension length [in m]	4.5
Outer coil diameter [in mm]	100.0
Cable color	yellow
Wire cross-sectional area	4x 3.0mm ² + 2x 5.0mm ² + 1x 8.0mm ²
Temperature resistance [in °C]	-40.0 - 85.0