

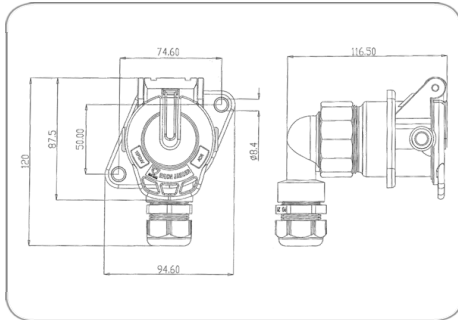

15P/24V "JAEGER Basic" socket (ISO 12098 ADR)



Art.Nr.
Part. No.

141155

Product group	Socket
Industry	Commercial vehicles
Area of application	Towing vehicle
No. of poles	15
Voltage [in V]	24
Standard	ISO 12098
Addition to standard	ADR
Branding	ERICH JAEGER
Packaging	PE bag
Content of package	crimp contact pins (3x 2.5mm ² + 12x 1.5mm ²), screw cap
Housing material	reinforced composite
Housing color	black
Cover material	reinforced composite
Cover color	black
Cable outlet	cap nut, cable outlet 90°
Contact version	contact pin with seal
Contact surface	nickel (Ni)
Contact termination	crimp contact
Type of seal	screw cap
For cable diameter	7,00mm - 12,00mm
Protection	IP X7,IP 54
Brand	JAEGER Basic